

3W552

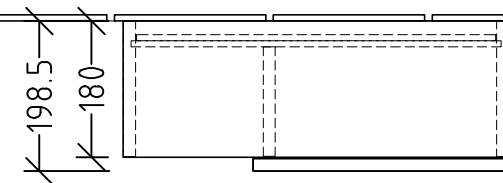
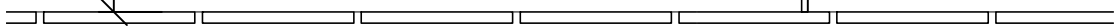
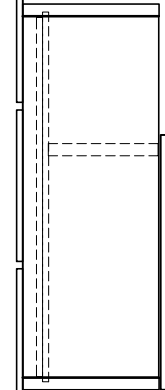
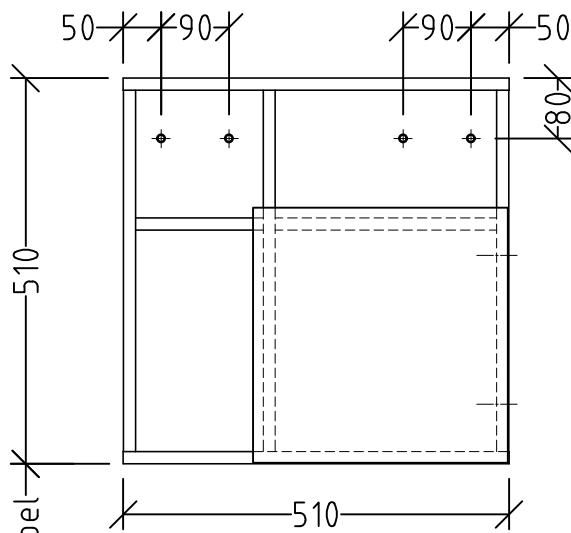
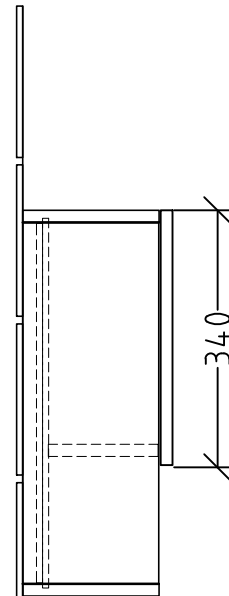
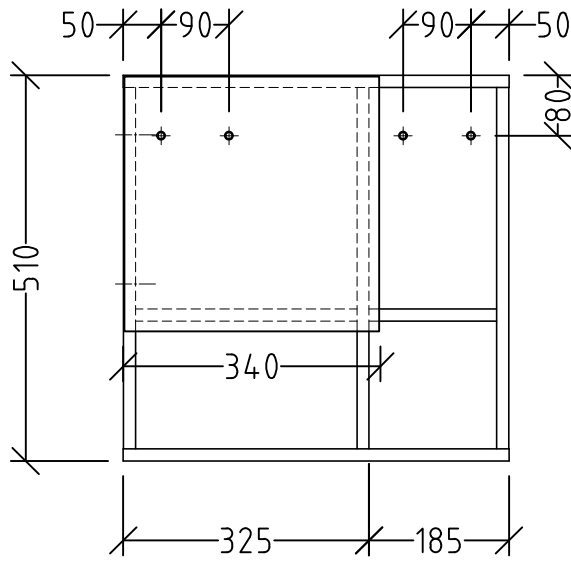

Anderung	Anderungstext	Revisor	Datum
		BR - BS	
Zeichnungs-Nr. 3WUEB_05		Bezeichnung Typenzeichnung - 3 Way Schränke	
Zeichner SKJ	Version A	Mat -	
Datum 08.06.2017		+/- Nach DIN 68100; HT 10	
K:\ACAD\ZEICHNG\System 3way\Übersicht			
Diese Zeichnung ist unser geistiges Eigentum und darf ohne unsere Genehmigung nicht kopiert oder Dritten zugänglich gemacht werden.			